

ASSEMBLY INSTRUCTIONS

ATTENTION: THIS PRODUCT IS NOT FOR COMMERCIAL USE
INTENDED FOR RESIDENTIAL USE ONLY.

RUS415W



- ⚠ Use the correct bolts as indicated. Do not tighten any of the bolts until the swing is completely assembled.
- ⚠ Do not discard any of the packaging until you have checked that you have all of the parts and fittings required.
- ⚠ Keep children away during assembly. This item contains small parts that can be swallowed by children. Children should always be under direct adult supervision while using this product.
- ⚠ Retain these assembly instructions for future reference.
- ⚠ Quote the following FQC NO. when contacting the service center.

SERVICE CENTER TOLL FREE NO.

TEL: 1-877-539-7436

FAX: 1-877-539-7439





DO NOT RETURN TO THE STORE!

PAGE 1 OF 7

COURTYARD CREATIONS INC.



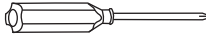







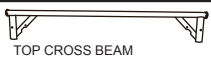
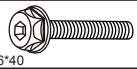

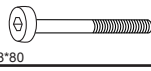







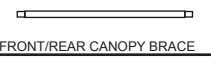

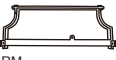

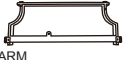



A. Read instructions thoroughly. Acquaint yourself with the inventory of parts and the accompanying drawings to ensure safe and proper assembly.

B. You will need the following tools:

- Phillips Screwdriver 
- Nut Wrench (See Part #33) 
- Hex. Key Wrench (See Part #31 and #32) 

C. Lay out all of the parts on a flat surface and identify them using the table below.

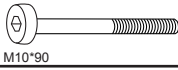
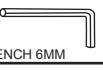
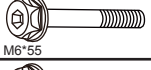
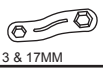
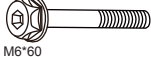
PARTS LIST

PART NO.	MATERIAL CODE	PART	Q'TY				
1	RUS4239-CS09-8	 TOP CROSS BEAM W/ADJUSTABLE TEETH	1	18	17C40A0714001YX	 BOLT M6*40	4
2	RUS4239-CS04-5	 FRONT UPRIGHT SUPPORT	2	19	17C01A0826011YX	 BOLT M8*80	2
3	RUS4239-CS04-6	 REAR UPRIGHT SUPPORT	2	20	17FA09070701-YX	 WASHER d10.5*D21*2.0	8
4	RUS4239-CS16-2	 LATERAL CROSS BRACE	2	21	17FA05050401-YX	 WASHER d6.5*D16*1.2	32
5	RUS415W-CS09-9	 REAR CROSS BRACE	1	22	17FA08060601-YX	 WASHER d8.5*D17*1.6	4
6	62RUS4040H102	 U-SHAPED SIDE CANOPY BRACE	2	23	17GA20405201-Y3	 SUSPENSION SPRING	2
7	62RUS42101101	 FRONT/REAR CANOPY BRACE	2	24	17D03A040401-YX	 JAM NUT M8*1.25	2
8	RUS415W-CS01-3	 RIGHT SEAT ARM	1	25	17D02A050501-YX	 STEEL NUT M10*1.5	4
9	RUS415W-CS01-2	 LEFT SEAT ARM	1	26	18000C23001---KX	 PLASTIC NUT M6*P1.0	16
10	62RUS416BH101	 SEAT FRONT SUPPORT	1	27	18000626005---KX	 CANOPY/FRAME CONNECTOR	2
11	RUS4239-CS09-7	 SEAT REAR SUPPORT	1	28	28000J59001---KX	 PLASTIC SCREW	2
12	RUS415W-CS02-1	 SEAT ASSEMBLY	1	29	1809030201----KX	 PLASTIC JOINT COVER	4
13	62RUS415WM101	 SWING ARM TUBE	4	30	18060616151401KX	 PLASTIC WASHER	2
14	17C17A1306001YX	 SCREW ST4.2*16	4	31	17KAA0101----Y4	 HEX. KEY WRENCH 4MM	1
15	17C01A0928051YX	 BOLT M10*90	4	32	17KAA0201----Y4	 HEX. KEY WRENCH 6MM	1
16	17C40A0719001YX	 BOLT M6*55	6	33	17KAB1201----Y4	 NUT WRENCH 13 & 17MM	1
17	17C40A0721001YX	 BOLT M6*90	6	34	61R415WD00001BA	 CANOPY	1
				35	61R415WC00001BA	 CUSHION	3



DO NOT RETURN TO THE STORE!

ASSEMBLY (Note: For all of the nuts and bolts fastening, always use a washer (#20, #21, or #22) between the tube and the bolt or the tube and the nut.)

Step 1:
Fasten the front and the rear upright supports (#2 and #3) at the top by using bolts (#15), washers (#20), and steel nuts (#25). Repeat the same procedure for both sides. Keep the bolts loose. See Fig. A – Step 1.

Step 2:
At both ends, insert the assembled upright supports (#2 and #3) into the top cross beam w/adjustable teeth (#1). See Fig. A – Step 2.

Step 3:
Fasten the top cross beam w/adjustable teeth (#1) to the front and the rear upright supports (#2 and #3) by using bolts (#15), washers (#20), and steel nuts (#25). Repeat the same procedure for both sides. See Fig. A – Step 3.

Step 4:
Fasten the lateral cross brace (#4) to upright supports (#2 and #3) by using bolts (#16), washers (#21), and plastic nuts (#26). Repeat the same procedure for both sides. See Fig. A – Step 4.

Step 5:
Fasten the rear cross brace (#5) to the rear upright supports (#3) by using bolts (#17), washers (#21), and plastic nuts (#26). Tighten all of the plastic nuts and bolts. See Fig. A – Step 5.

Note:
The labeled arrow marks on the rear cross brace (#5) should be facing upwards.

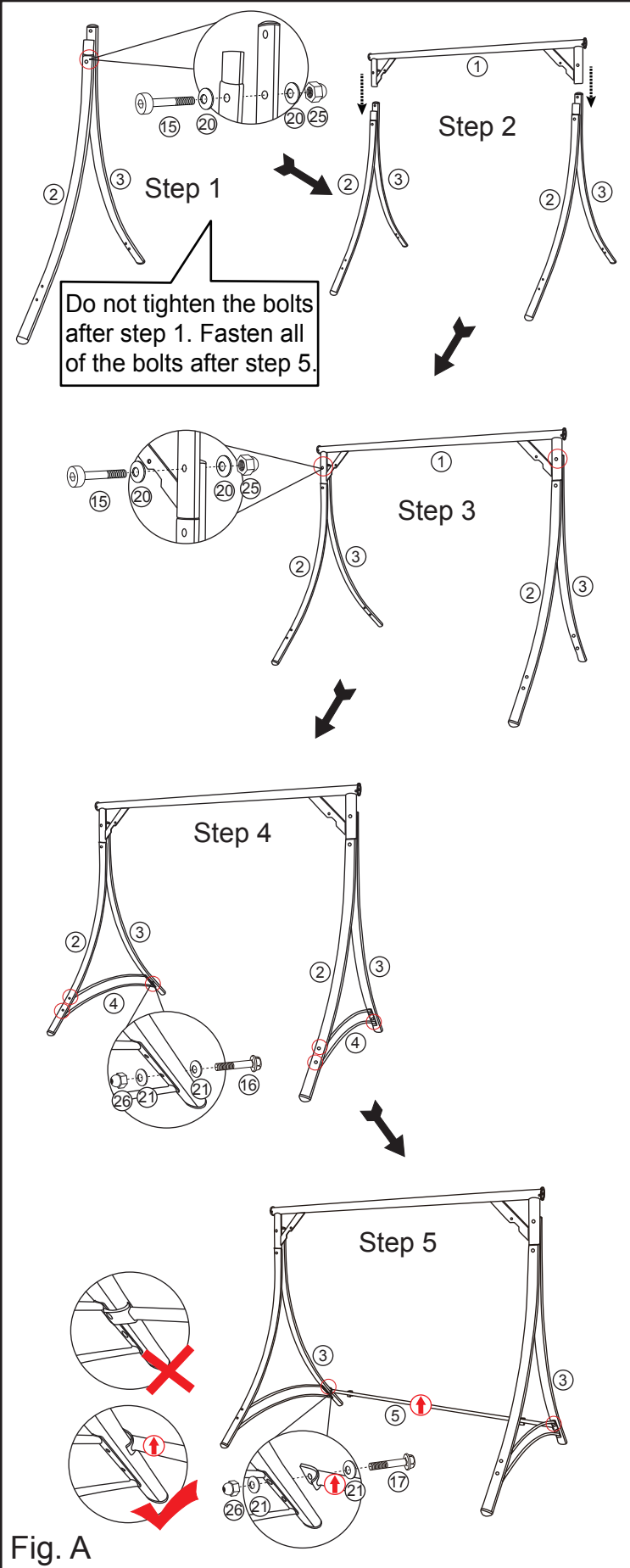
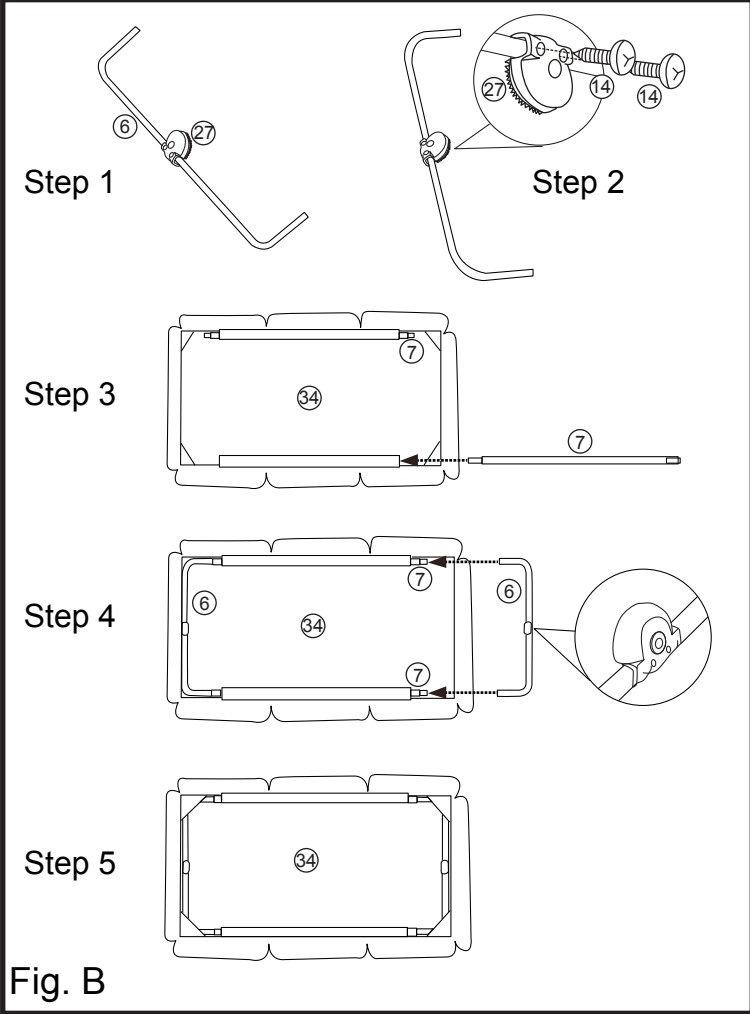

Fig. A



DO NOT RETURN TO THE STORE!
PAGE 3 OF 7

Step 6:
 Insert the U-shaped side canopy braces (#6) into the canopy frame connectors (#27) and secure in place by using screws (#14). Make sure that the teeth on the canopy frame connectors are facing towards the inside. See Fig. B – Step 1 and Step 2.



Step 7:
 Insert the front/rear canopy braces (#7) into the sleeves on the canopy (#34). See Fig. B – Step 3.

Step 8:
 Insert the front/rear canopy brace (#7) ends into the U-shaped side canopy braces (#6). See Fig. B – Step 4.

Step 9:
 Insert the four corners of the U-shaped side canopy braces (#6) into the pockets on the canopy (#34). See Fig. B – Step 5.

Step 10:
 Fasten the canopy/frame connectors (#34) on the canopy assembly to the adjustable teeth on the top cross beam w/adjustable teeth (#1) by using plastic screws (#28). Repeat this procedure for both sides. See Fig. C – Step 1 and Step 2.

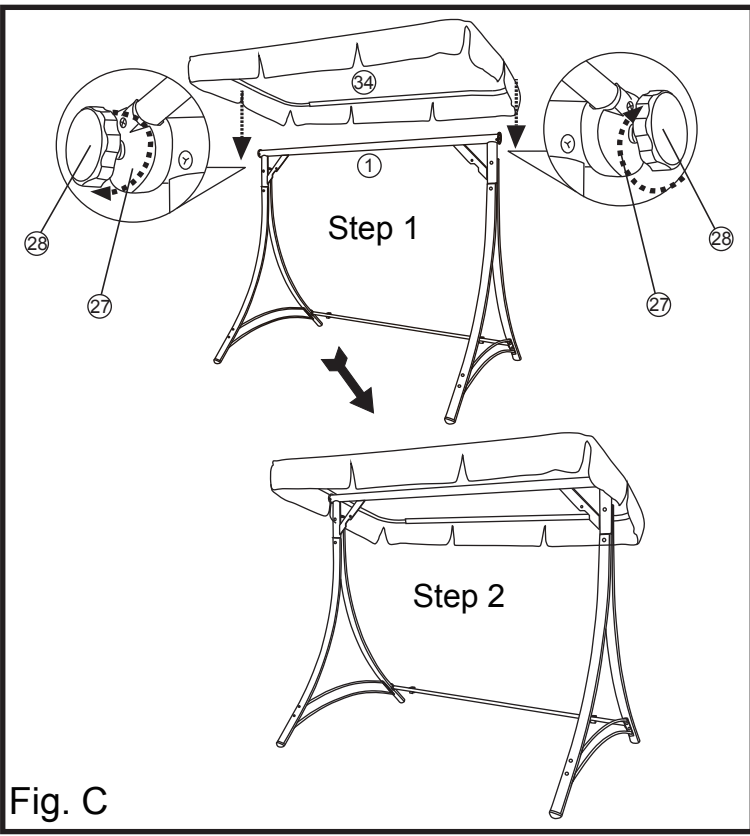

DO NOT RETURN TO THE STORE!
 PAGE 4 OF 7

Step 11:
 Insert seat arms (#8 and #9) into seat supports (#10 and #11) and fasten them together by using plastic joint covers (#29), bolts (#18), washers (#21), and plastic nuts (#26).
 See Fig. D – Step 1.

- Note:**
1. The label marked "back" on the right seat arm (#8) should coincide with the label marked "back" on the seat rear support (#11).
 2. The clip holder side of the seat rear support (#11) must face toward the inside of the swing and the opening side of the clip holder must be facing upward.

Step 12:
 Open the seat assembly (#12) and fasten its back to seat arms (#8 and #9) by using bolts (#19), washers (#22), plastic washers (#30), and jam nuts (#24). Repeat the same procedure for both sides. See Fig. D – Step 2.

Step 13:
 Make sure that the support brace on the seat assembly (#12) is fully inserted into the clip holders on the seat rear support (#11).
 See Fig. D – Step 3.

Step 14:
 Attach the swing arm tubes (#13) to seat arms (#8 and #9) by using bolts (#17), washers (#21), and plastic nuts (#26). Repeat the same procedure for both sides. See Fig. D – Step 4.

Step 15:
 Hook the suspension springs (#23) into the top of both holes in the swing arm tubes (#13). Repeat the same procedure for both sides. See Fig. D – Step 5.

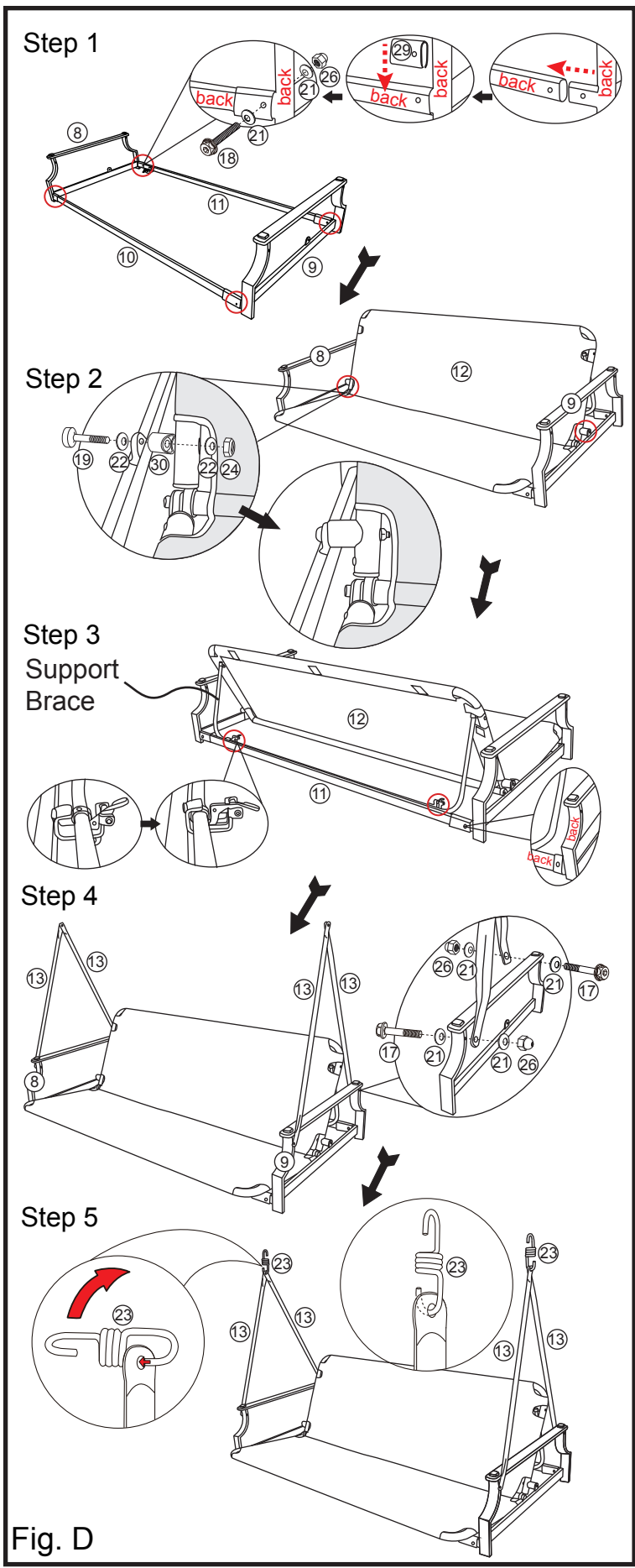

Fig. D



DO NOT RETURN TO THE STORE!
 PAGE 5 OF 7

Step 16:
Insert the opposite ends of the suspension springs (#23) into the holes located in the angled braces on the top cross beam w/adjustable teeth (#1). See Fig. E.

Warning:
Make sure that both ends of the suspension springs (#24) go completely through the holes in the angled braces on the top cross beam w/adjustable teeth (#1) and the swing arm tubes (#13).

Step 17:
To assure stability, double check that all of the bolts have been tightened completely.

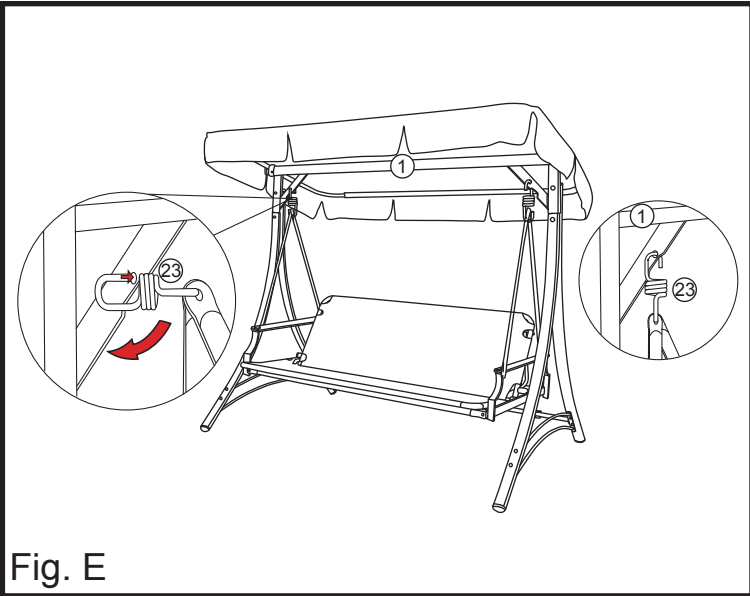

Fig. E

Step 18:
Place the cushions (#35) onto the seat assembly (#12). See Fig. F.

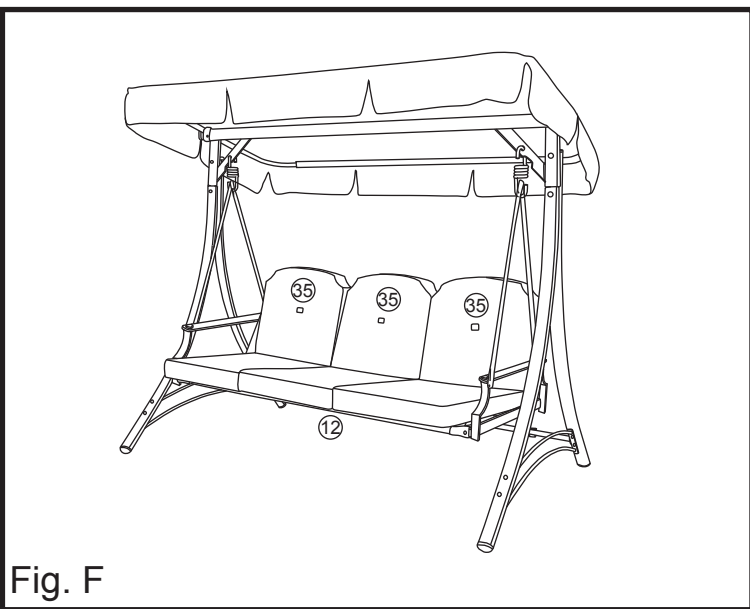

Fig. F

Step 19:
Make sure that the safety locks on the seat rear support (#11) are fully locked whenever the seat assembly is in a swinging position. See Fig. G – 1 (SEAT). To have the swing in a bed position, open both of the safety locks. See Fig. G – 2 (BED).

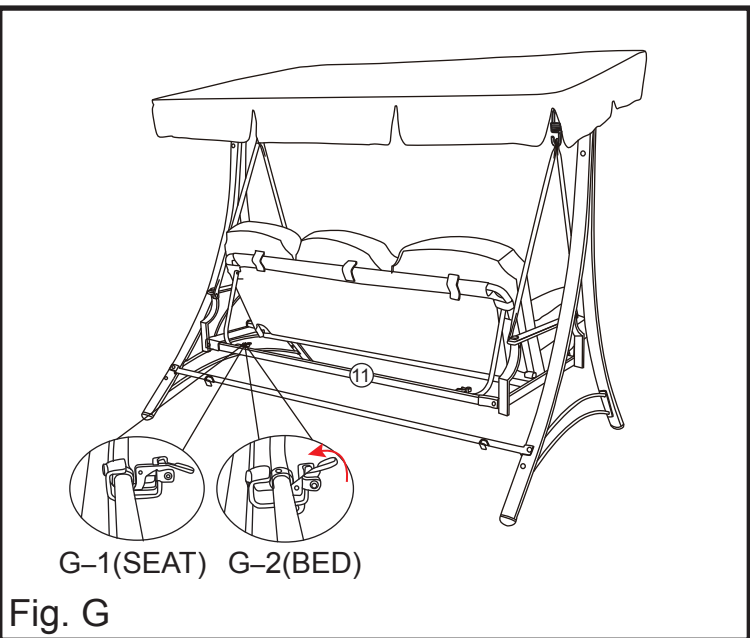

Fig. G



DO NOT RETURN TO THE STORE!
PAGE 6 OF 7

Step 20:

To flatten the seat assembly, lift up the safety locks and remove the support brace.

See Fig. H1 and Fig. H2.

Then, insert the support brace into the rear cross brace (#5). The seat assembly should now be in a secured position and not moving at all. See Fig. H3, Fig. H4, and Fig. H5.

Warning:

To avoid danger of suffocation, always keep plastic bags or small parts away from babies and children.

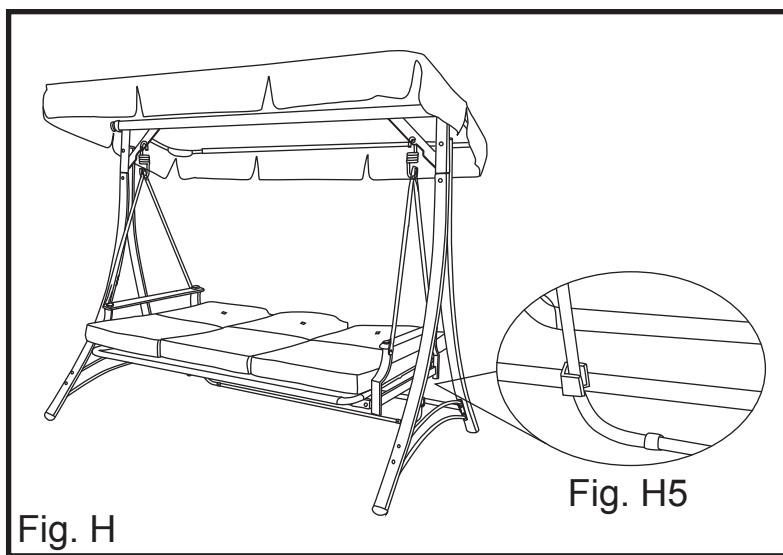

Fig. H

Fig. H5

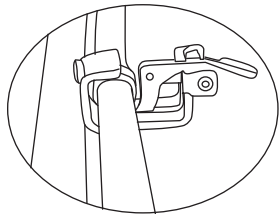

Fig. H1

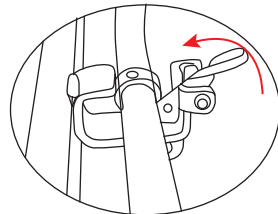

Fig. H2

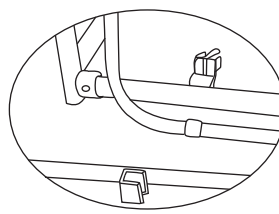

Fig. H3

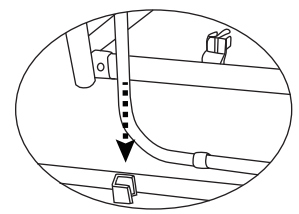

Fig. H4

Cleaning and Maintenance

- Wash frame and fabric parts with mild soap and water, rinse thoroughly, and dry completely. Do not use bleach, acid, or other solvents on the frame or fabric parts.
- The cushions and canopy may be washed on the surface only by using mild soap and water or commercial foaming upholstery cleaner if necessary. If washed, rinse well and hang to dry. Do not machine wash or dry.
- We recommend the use of furniture covers when not in use.
- Inspect and tighten all bolts and fasteners on a regular basis to ensure the proper performance and safety of your swing.
- In order to prolong the life and beauty of your swing, we recommend that it be stored in a dry and protected area during off season periods.

Warranty

- This product is covered by Courtyard Creations Inc.'s one-year limited warranty.
- Proof of purchase (dated register receipt) is required for warranty claims.
- It remains the customer's responsibility for freight and packing charges to and from the service center.

Special Warnings

1. The user of this swing should always inspect it before each use.
2. It is essential to place this swing on level ground and not less than 6 feet away from any obstruction; such as fences, garages, houses, overhanging branches, laundry lines, or electrical wires.
3. Check the tightness of the nuts and bolts on a regular basis.
4. Make sure that the suspension springs are properly secured before each use.
5. Always remove the canopy in heavy wind conditions. Otherwise, the swing may tip over and cause damage to its parts.
6. The manufacturer will not accept responsibility for unauthorized repairs or modifications to the swing or its parts.
7. Oil all of the metal parts that move regularly.
8. The weight limit is 750 lbs.



READ THESE INSTRUCTIONS COMPLETELY BEFORE STARTING ASSEMBLY

- ★ SEPARATE AND IDENTIFY ALL OF THE PARTS, MAKING SURE THAT YOU HAVE ALL OF THE PARTS LISTED.
- ★ IF YOU DO NOT LOCATE ALL OF THE PARTS LISTED, INSPECT THE PACKING MATERIAL FOR SMALL PARTS THAT MAY HAVE BECOME SEPARATED DURING SHIPMENT.
- ★ IF YOU EXPERIENCE ANY DIFFICULTY DURING ASSEMBLY OR IF ANY PARTS ARE MISSING OR DAMAGED, CALL THE HELP LINE AT 1-877-539-7436 BEFORE RETURNING THIS ITEM TO THE STORE.
- ★ PROVIDE THE FOLLOWING INFORMATION WHEN CALLING:
1-MODEL NUMBER OF THE PRODUCT.
2-PART NUMBER AND MATERIAL CODE OF THE PART FROM THE PARTS LIST.
- ★ MOST PROBLEMS CAN BE RESOLVED WITHOUT RETURNING THIS PRODUCT TO THE RETAILER.



DO NOT RETURN TO THE STORE!

PAGE 7 OF 7

INSTRUCCIONES DE ARMADO

ATENCIÓN: ESTE PRODUCTO NO ES PARA USO COMERCIAL; ESTÁ DISEÑADO ÚNICAMENTE PARA USO RESIDENCIAL.

RUS415W



- ⚠ Utilice los tornillos correctos, según se indica. No apriete ninguno de los tornillos hasta que el columpio esté completamente ensamblado.
- ⚠ No tire el empaque hasta que haya comprobado que tiene todas las partes y los accesorios necesarios.
- ⚠ No deje que los niños se acerquen durante el ensamblado. Este producto contiene piezas pequeñas que los niños pueden ingerir. Mientras usen este producto, los niños siempre deberán estar bajo la supervisión directa de un adulto.
- ⚠ Conserve estas instrucciones para referencia futura.
- ⚠ Cuando se comunique con el centro de servicio, proporcione siempre el siguiente código de control de calidad (FQC, por sus siglas en inglés).

NÚMERO GRATUITO DEL CENTRO DE SERVICIO

TEL: 1-877-539-7436

FAX: 1-877-539-7439





¡NO DEVUELVA ESTE PRODUCTO A LA TIENDA!

PÁGINA 1 DE 7

COURTYARD CREATIONS INC.



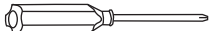







A. Lea las instrucciones cuidadosamente. Familiarícese con el inventario de partes y las ilustraciones correspondientes para que pueda armar el columpio segura y adecuadamente.



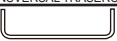

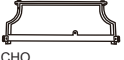
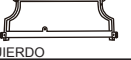

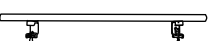
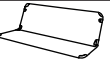

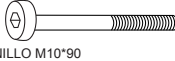
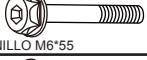
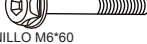

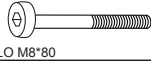



B. Se necesitan las siguientes herramientas:

- Desarmador de cruz 
- Llave de tuercas (vea la parte #33) 
- Llave Allen (vea las partes #31 y #32) 

C. Extienda todas las partes en una superficie plana e identifíquelas con ayuda de la siguiente tabla:

LISTA DE PARTES

No. DE PARTE	CÓDIGO DE MATERIAL	PORTE	CANT.
1	RUS4239-CS09-8	 BARRA TRANSVERSAL SUPERIOR CON DIENTES AJUSTABLES	1
2	RUS4239-CS04-5	 SOPORTE VERTICAL DELANTERO	2
3	RUS4239-CS04-6	 SOPORTE VERTICAL TRASERO	2
4	RUS4239-CS16-2	 REFUERZO TRANSVERSAL LATERAL	2
5	RUS415W-CS09-9	 REFUERZO TRANSVERSAL TRASERO	1
6	62RUS4040H102	 ARMAZÓN LATERAL DEL TOLDO EN FORMA DE U	2
7	62RUS4210I101	 TRAVESAÑO DELANTERO/TRASERO DEL TOLDO	2
8	RUS415W-CS01-3	 BRAZO DERECHO	1
9	RUS415W-CS01-2	 BRAZO IZQUIERDO	1
10	62RUS416BH101	 SOPORTE DELANTERO DEL ASIENTO	1
11	RUS4239-CS09-7	 SOPORTE TRASERO DEL ASIENTO	1
12	RUS415W-CS02-1	 ASIENTO	1
13	62RUS415WM101	 TUBO DEL DESCANSABRAZOS	4
14	17C17A1306001YX	 TORNILLO ST4.2*16	4
15	17C01A0928051YX	 TORNILLO M10*90	4
16	17C40A0719001YX	 TORNILLO M6*55	6
17	17C40A0721001YX	 TORNILLO M6*60	6

18	17C40A0714001YX	 TORNILLO M6*40	4
19	17C01A0826011YX	 TORNILLO M8*80	2
20	17FA09070701-YX	 RONDANA d10.5*D21*2.0	8
21	17FA05050401-YX	 RONDANA d6.5*D16*1.2	32
22	17FA08060601-YX	 RONDANA d8.5*D17*1.6	4
23	17GA20405201-Y3	 RESORTE DE SUSPENSIÓN	2
24	17D03A040401-YX	 TUERCA DE SEGURIDAD M8*1.25	2
25	17D02A050501-YX	 TUERCA DE ACERO M10*1.5	4
26	18000C23001---KX	 TUERCA DE PLÁSTICO M6*P1.0	16
27	18000626005---KX	 CONECTOR TOLDO-ARMAZÓN	2
28	28000J59001---KX	 TORNILLO DE PLÁSTICO	2
29	1809030201----KX	 CUBIERTA DE PLÁSTICO PARA JUNTAS	4
30	18060616151401KX	 JUNTA DE PLÁSTICO	2
31	17KAA0101----Y4	 LLAVE ALLEN DE 4MM	1
32	17KAA0201----Y4	 LLAVE ALLEN DE 6MM	1
33	17KAB1201----Y4	 LLAVE DE TUERCAS DE 13 Y 17MM	1
34	61R415WD00001BA	 TOLDO	1
35	61R415WC00001BA	 COJÍN	3



ENSAMBLADO (Nota: Para unir las tuercas con los tornillos, coloque siempre una rondana (#20, #21 o #22) entre el tubo y el tornillo o entre el tubo y la tuerca.)

Paso 1:
Sujete los soportes verticales delantero y trasero (#2 y #3) en la parte superior con ayuda de los tornillos (#15), las rondanas (#20) y las tuercas de acero (#25). Repita el mismo procedimiento para ambos lados. Deje los tornillos flojos. Consulte la figura A, paso 1.

Paso 2:
En ambos extremos, inserte los soportes verticales armados (#2 y #3) en la barra transversal superior con dientes ajustables (#1). Consulte la figura A, paso 2.

Paso 3:
Sujete la barra transversal superior con dientes ajustables (#1) a los soportes verticales delantero y trasero (#2 y #3) con ayuda de los tornillos (#15), las rondanas (#20) y las tuercas de acero (#25). Repita el mismo procedimiento para ambos lados. Consulte la figura A, paso 3.

Paso 4:
Sujete el refuerzo transversal lateral (#4) a los soportes verticales (#2 y #3) con ayuda de los tornillos (#16), las rondanas (#21) y las tuercas de plástico (#26). Repita el mismo procedimiento para ambos lados. Consulte la figura A, paso 4.

Paso 5:
Sujete el refuerzo transversal trasero (#5) a los soportes verticales traseros (#3) con ayuda de los tornillos (#17), las rondanas (#21) y las tuercas de plástico (#26). Apriete todas las tuercas de plástico y los tornillos. Consulte la figura A, paso 5.

Nota:
Las flechas del refuerzo transversal trasero (#5) deben dar hacia arriba.

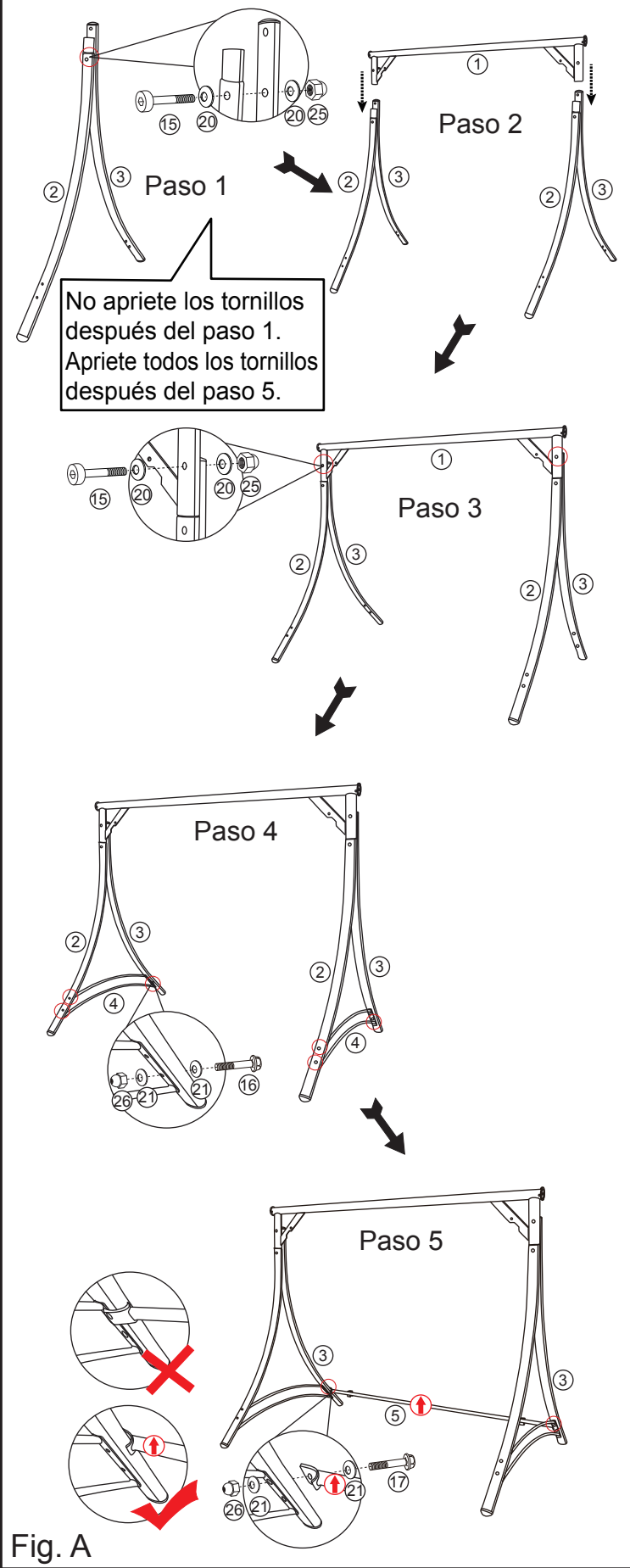
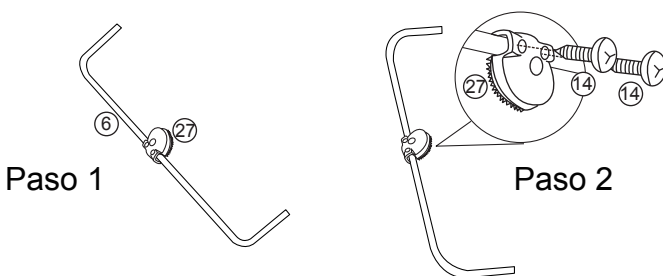

Fig. A



¡NO DEVUELVA ESTE PRODUCTO A LA TIENDA!

Paso 6:
 Inserte los armazones laterales del toldo en forma de U (#6) en los conectores toldo-armazón (#27) y fíjelos con ayuda de los tornillos (#14). Asegúrese de que los dientes de los conectores toldo-armazón den hacia adentro. Consulte la figura B, pasos 1 y 2.



Paso 7:
 Inserte los armazones delantero y trasero del toldo (#7) en las mangas del toldo (#34). Consulte la figura B, paso 3.

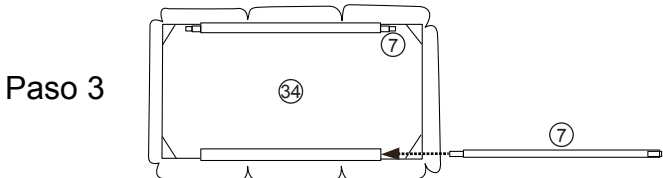

Paso 8:
 Inserte los extremos del travesaño delantero/trasero del toldo (#7) en los armazones laterales del toldo en forma de U (#6). Consulte la figura B, paso 4.

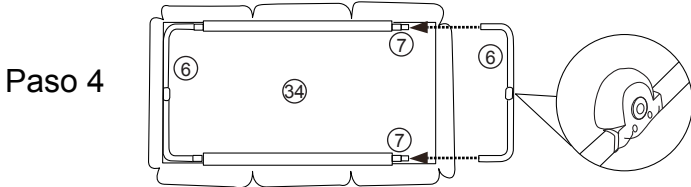

Paso 9:
 Inserte las cuatro esquinas de los armazones laterales del toldo en forma de U (#6) en los bolsillos del toldo (#34). Consulte la figura B, paso 5.

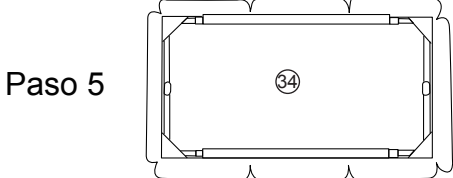

Fig. B

Paso 10:
 Sujete los conectores toldo-armazón (#34) del armazón ensamblado a los dientes ajustables de la barra transversal superior (#1) con ayuda de los tornillos de plástico (#28). Repita el mismo procedimiento para ambos lados. Consulte la figura C, pasos 1 y 2.

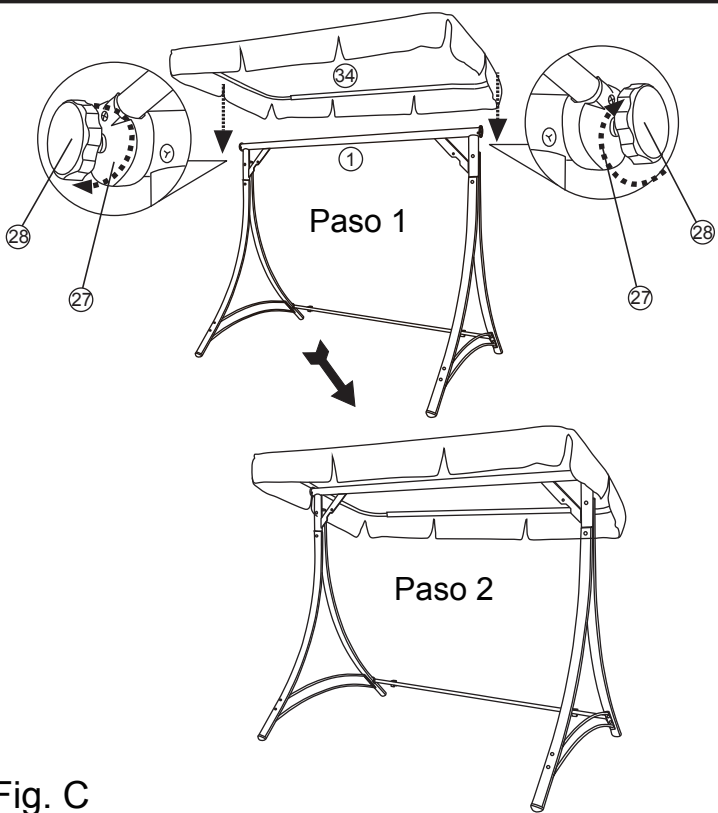

Fig. C



¡NO DEVUELVA ESTE PRODUCTO A LA TIENDA!
 PÁGINA 4 DE 7

Paso 11:

Inserte los brazos del asiento (#8 y #9) en los soportes del asiento (#10 y #11) y sujételos con ayuda de las cubiertas de plástico para juntas (#29), los tornillos (#18), las rondanas (#21) y las tuercas de plástico (#26).

Consulte la figura D, paso 1.

Nota:

1. La etiqueta marcada como "back" ("parte trasera") en el brazo derecho del asiento (#8) debe coincidir con la etiqueta marcada como "back" ("parte trasera") del soporte trasero del asiento (#11).
2. El lado del soporte trasero del asiento (#11) que tiene los sujetadores de clip debe dar hacia adentro del columpio y el extremo de los clips que se abre debe dar hacia arriba.

Paso 12:

Desdoble el asiento (#12) y fije el respaldo a los brazos (#8 y #9) con ayuda de los tornillos (#19), las rondanas (#22), las juntas de plástico (#30) y las tuercas de seguridad (#24). Repita el mismo procedimiento para ambos lados.

Consulte la figura D, paso 2.

Paso 13:

Asegúrese de que el soporte del asiento (#12) esté completamente insertado en los sujetadores de clip del soporte trasero del asiento (#11). Consulte la figura D, paso 3.

Paso 14:

Sujete los tubos de los descansabrazos (#13) a los brazos del asiento (#8 y #9) con ayuda de los tornillos (#17), las rondanas (#21) y las tuercas de plástico (#26). Repita el mismo procedimiento para ambos lados.

Consulte la figura D, paso 4.

Paso 15:

Enganche los resortes de suspensión (#23) en la parte superior de los agujeros de los tubos de los descansabrazos (#13). Repita el mismo procedimiento para ambos lados.

Consulte la figura D, paso 5.

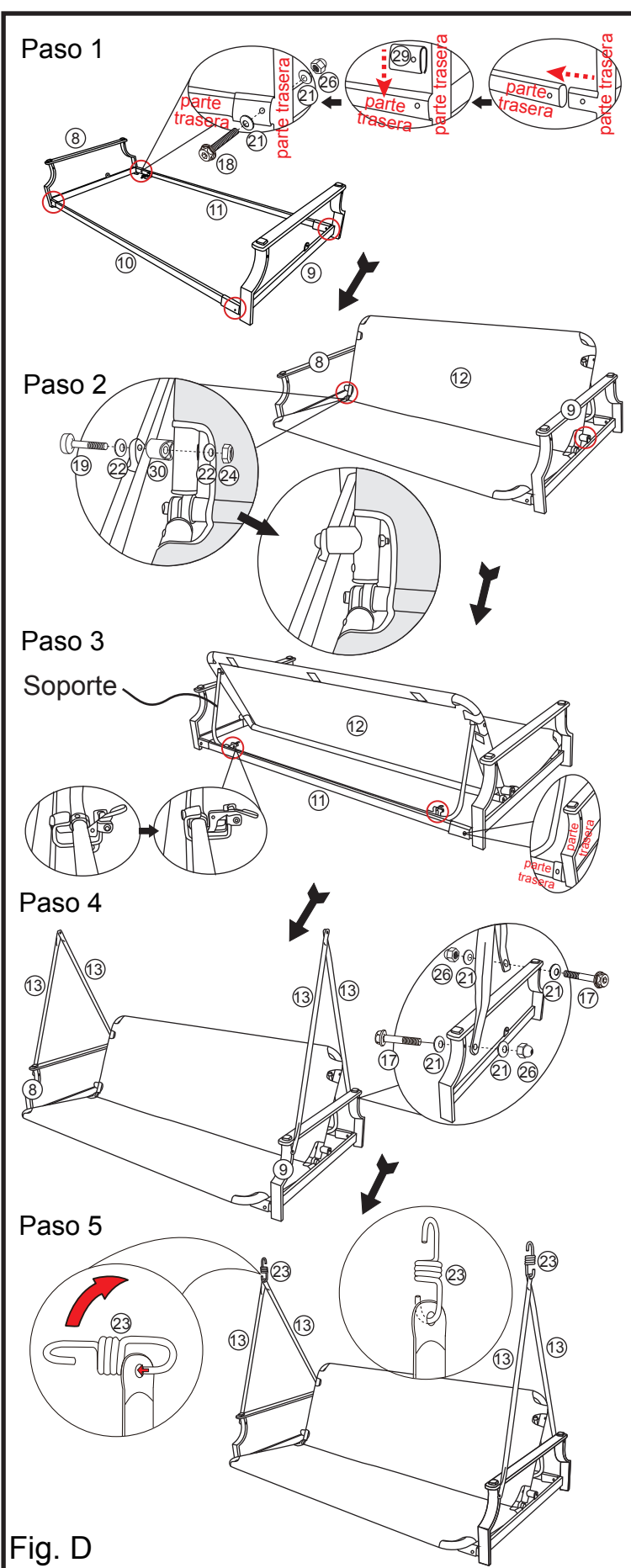

Fig. D



¡NO DEVUELVA ESTE PRODUCTO A LA TIENDA!

PÁGINA 5 DE 7

Paso 16:
Inserte el otro extremo de los resortes de suspensión (#23) en los agujeros de los soportes diagonales de la barra transversal superior con dientes ajustables (#1).
Consulte la figura E.

Advertencia:
Asegúrese de que ambos extremos de los resortes de suspensión (#24) entren completamente en los agujeros de los soportes diagonales de la barra transversal superior con dientes ajustables (#1) y los tubos de los descansabrazos (#13).

Paso 17:
Para garantizar la estabilidad de la estructura, revise que todos los tornillos estén completamente apretados.

Paso 18:
Coloque los cojines (#35) en el asiento (#12).
Consulte la figura F.

Paso 19:
Verifique que los seguros del soporte trasero del asiento (#11) estén completamente trabados siempre que el asiento esté en posición de columpio. Consulte la figura G - 1 (ASIENTO).
Para colocar el columpio en posición de cama, destrabe ambos seguros. Consulte la figura G - 2 (CAMA).

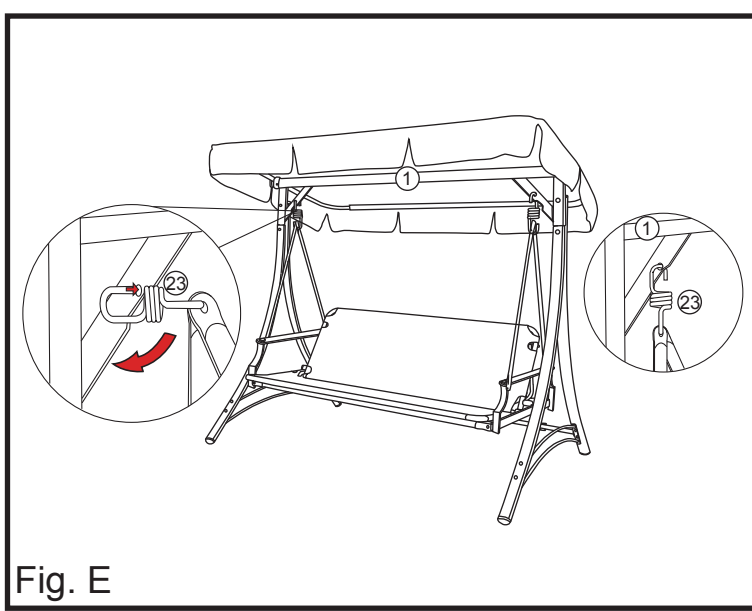

Fig. E

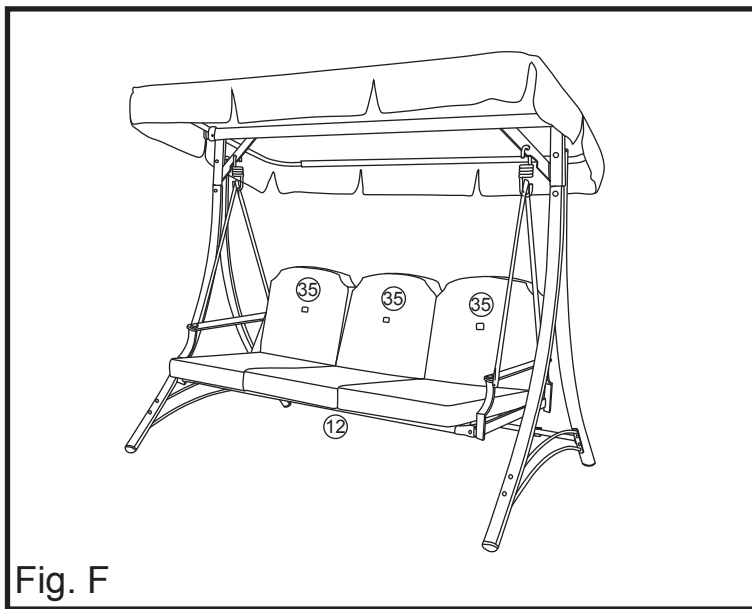

Fig. F

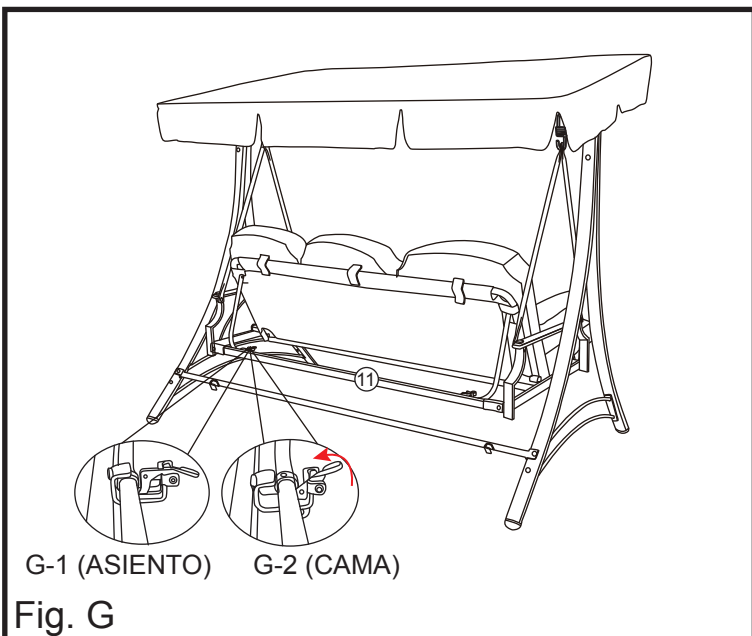

Fig. G



¡NO DEVUELVA ESTE PRODUCTO A LA TIENDA!

PÁGINA 6 DE 7

Paso 20:

Para colocar el asiento en posición horizontal, levante los seguros y quite el soporte. Consulte las figuras H1 y H2. Luego, inserte el soporte en el refuerzo transversal trasero (#5). El asiento debe estar fijo y no moverse en absoluto. Consulte las figuras H3, H4 y H5.

Advertencia:

Para evitar el peligro de asfixia, mantenga las bolsas de plástico y las piezas pequeñas fuera del alcance de bebés y niños.

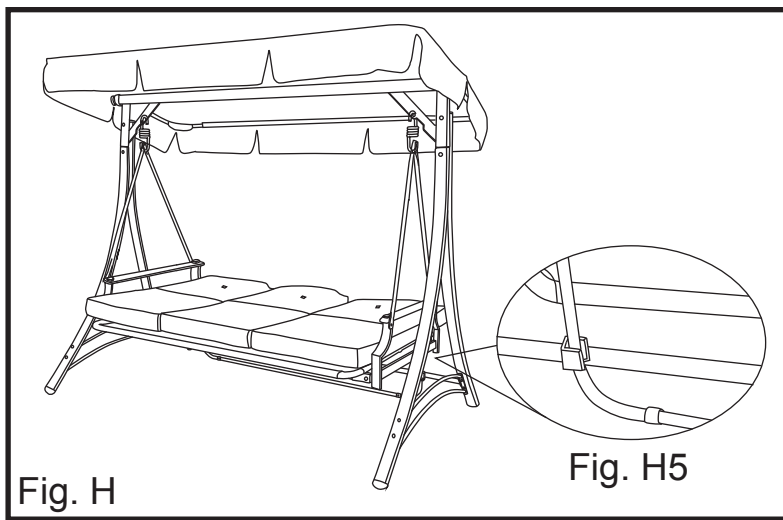

Fig. H

Fig. H5

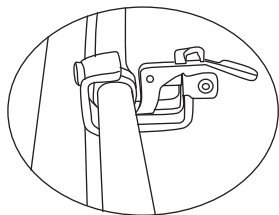

Fig. H1

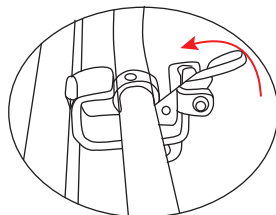

Fig. H2

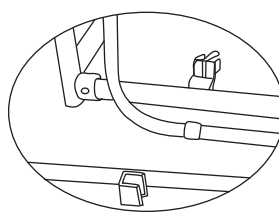

Fig. H3

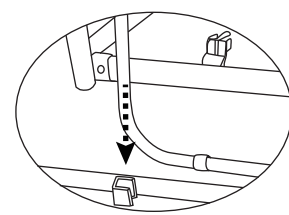

Fig. H4

Limpieza y mantenimiento

- Lave el marco y las partes de tela con agua y jabón suave, enjuáguelos muy bien y déjelos secar completamente. No aplique blanqueadores, ácidos ni ningún otro solvente al marco ni a las partes de tela.
- Los cojines y el toldo solo se pueden lavar superficialmente con agua y jabón suave o con espuma comercial para limpiar muebles, en caso necesario. Si los lava, enjuáguelos bien y póngalos a secar colgados. No los lave a máquina ni en seco.
- Se recomienda cubrir el columpio con una funda cuando no esté en uso.
- Revise y apriete todos los tornillos y medios de fijación periódicamente para garantizar el funcionamiento adecuado y la seguridad de su columpio.
- Para prolongar la vida y la belleza de su columpio, le recomendamos almacenarlo en un lugar seco y bien protegido en las temporadas del año en que no lo use.

Garantía

- Este producto está cubierto por una garantía limitada de un año con Courtyard Creations Inc.
- Para cualquier reclamación de la garantía es necesario presentar el comprobante de compra (recibo de caja registradora con fecha).
- El cliente será responsable por los cargos de empaque y envío a y desde el centro de servicio.

Advertencias especiales

1. Inspeccione siempre el columpio antes de usarlo.
2. Es esencial que coloque el columpio en una superficie plana dejando un margen de al menos de 6 pies (1.80m) respecto de cualquier obstrucción, como rejas, cocheras, casas, ramas bajas de árboles, tendederos o cables eléctricos.
3. Revise periódicamente que las tuercas y los tornillos estén bien apretados.
4. Antes de cada uso, verifique que los resortes de suspensión estén bien fijados.
5. Si hace mucho viento, quite el toldo. De lo contrario, el columpio podría volcarse y dañarse.
6. El fabricante no se hace responsable de ninguna reparación o modificación no autorizada que se le haga al columpio o sus partes.
7. Aceite regularmente todas las piezas metálicas móviles.
8. El límite de peso es de 750 lbs (340 kg).

¡ALTO!
¿Le falta alguna pieza?
No es necesario que regrese a la tienda

La tienda donde adquirió este artículo no tiene partes sueltas en existencia.
Si necesita alguna pieza, ya sea por extraviado o daño, llame sin costo al:
TEL.: 1-877-539-7436
FAX: 1-877-539-7439
Lo atenderemos de 9:00 am a 4:30 pm, hora del Este, de lunes a viernes
Si requiere más ayuda, escribanos a service.cci@polywares.com

LEA ESTAS INSTRUCCIONES COMPLETAMENTE ANTES DE EMPEZAR EL ARMADO

- ★ SEPARA E IDENTIFIQUE TODAS LAS PARTES Y ASEGÚRESE DE QUE TENGA TODAS LAS PARTES DE LA LISTA.
- ★ SI NO ENCUENTRA TODAS LAS PARTES DE LA LISTA, REVISE EL MATERIAL DE EMPAQUE. LAS PARTES PEQUEÑAS A VECES SE SEPARAN DURANTE EL TRASLADO.
- ★ SI TIENE DIFICULTADES PARA ENSAMBLAR EL PRODUCTO O SI ALGUNA PIEZA ESTÁ DAÑADA O FALTA, LLAME A LA LÍNEA DE AYUDA AL 1-877-539-7436 ANTES DE DEVOLVER EL PRODUCTO A LA TIENDA.
- ★ CUANDO LLAME, PROPORCIONE LA SIGUIENTE INFORMACIÓN:
1-NÚMERO DE MODELO DEL PRODUCTO
2-NÚMERO DE PARTE Y CÓDIGO DE MATERIAL SEGÚN LA LISTA DE PARTES
- ★ LA MAYORÍA DE LOS PROBLEMAS PUEDEN RESOLVERSE SIN NECESIDAD DE DEVOLVER EL PRODUCTO A LA TIENDA.

ALTO

¡NO DEVUELVA ESTE PRODUCTO A LA TIENDA!
PÁGINA 7 DE 7